

Agriculture, Labourage.

Benard fecit.

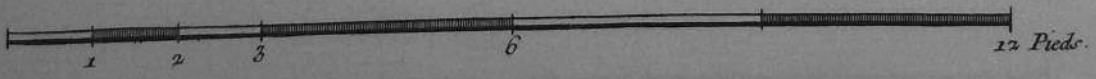

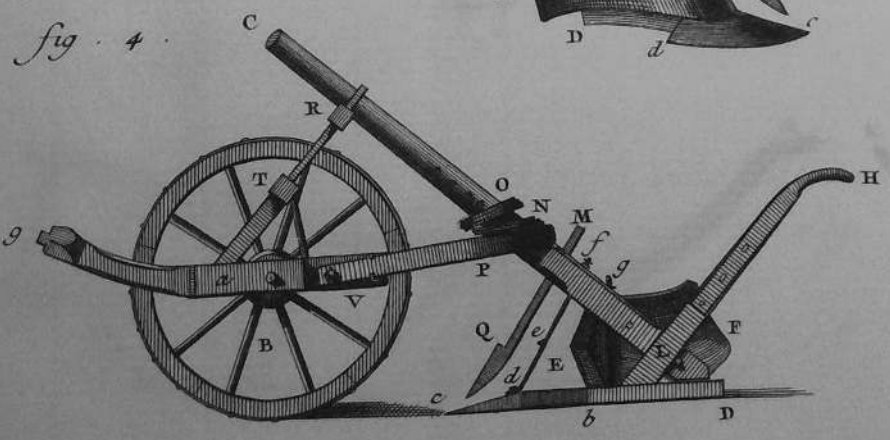
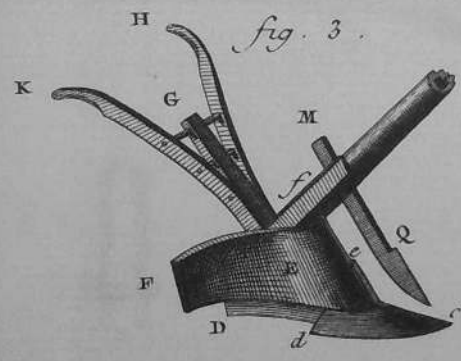
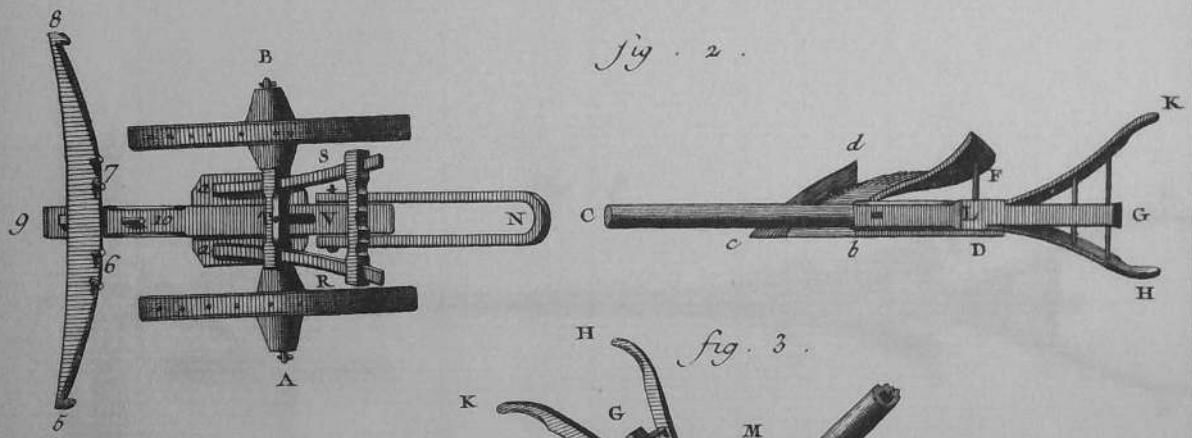
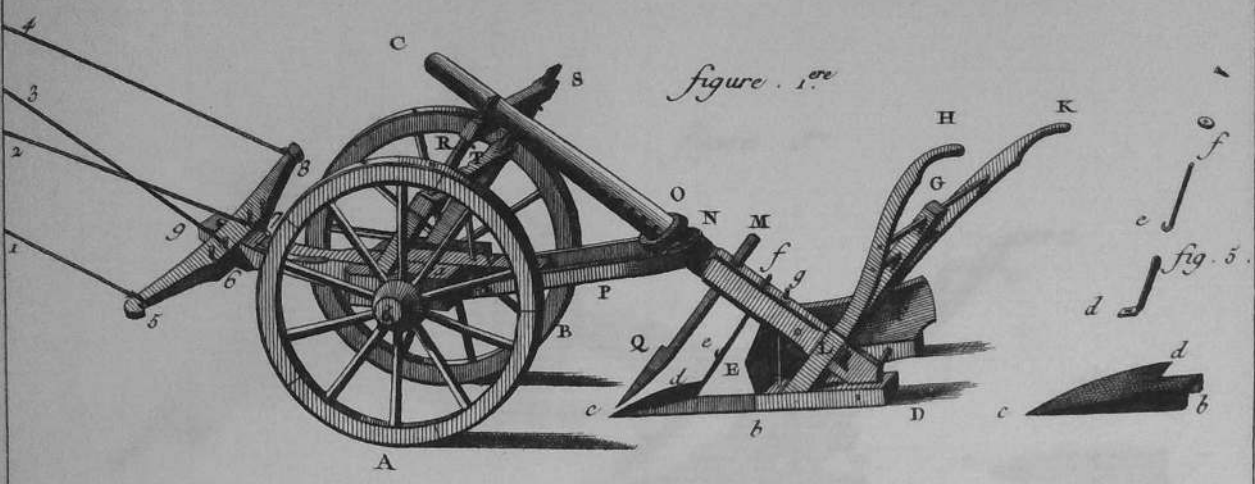
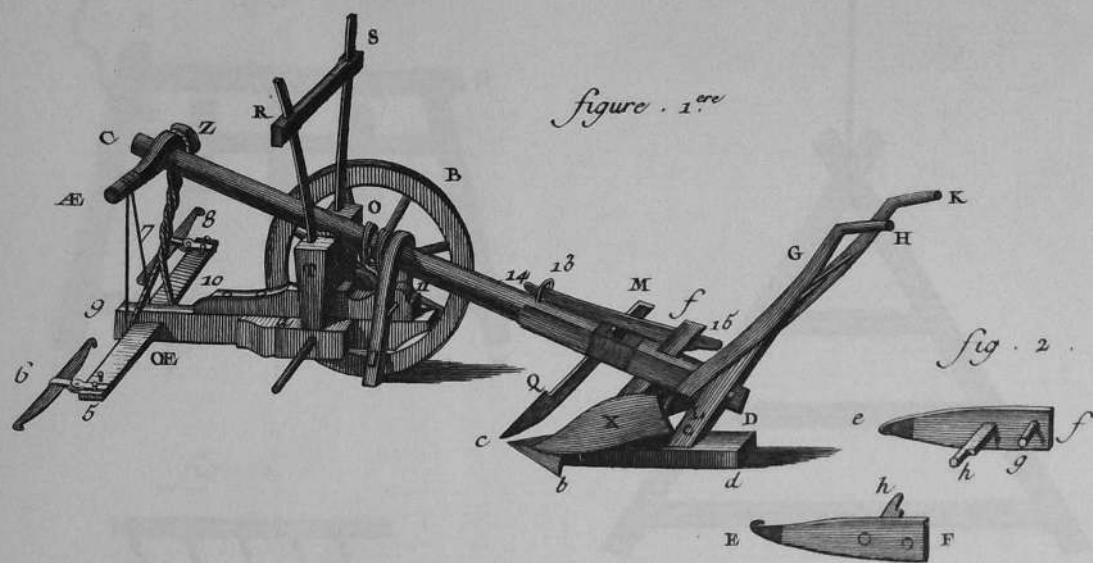

fig. 2.

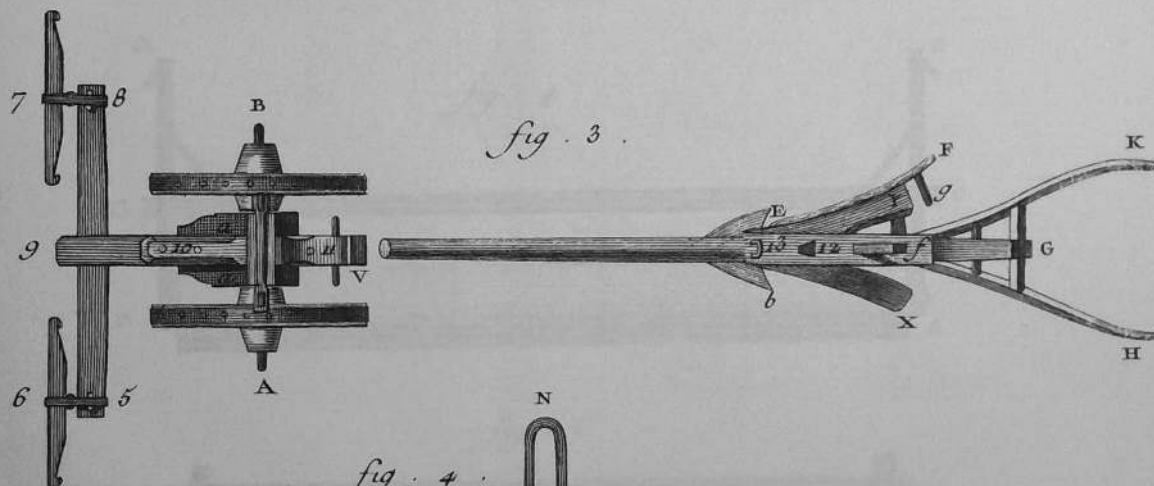
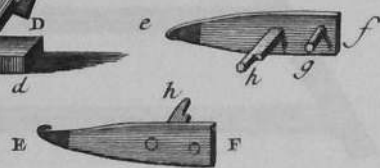
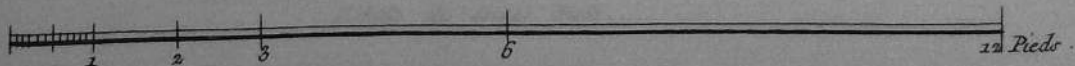
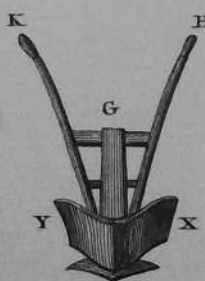
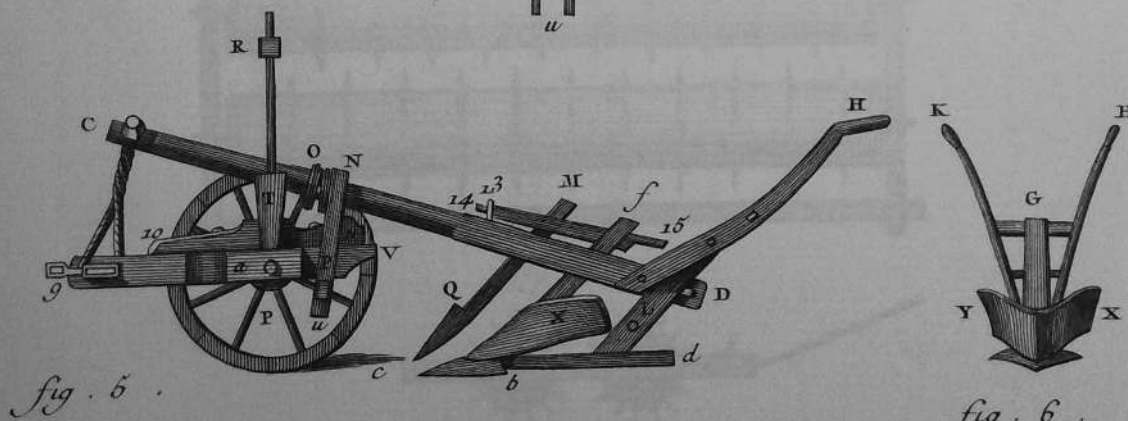
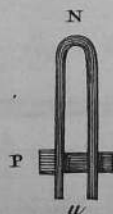

fig. 4.



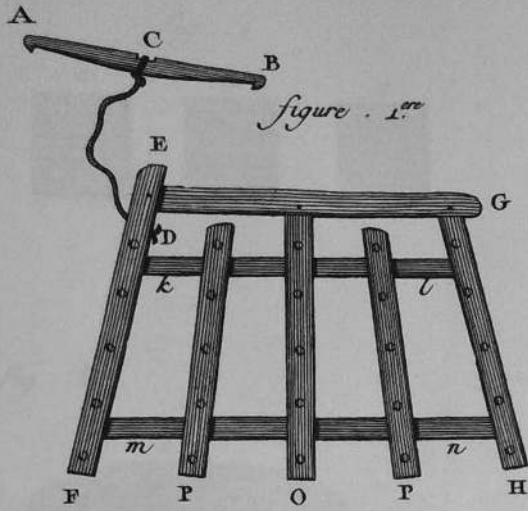

figure . 1^{re}

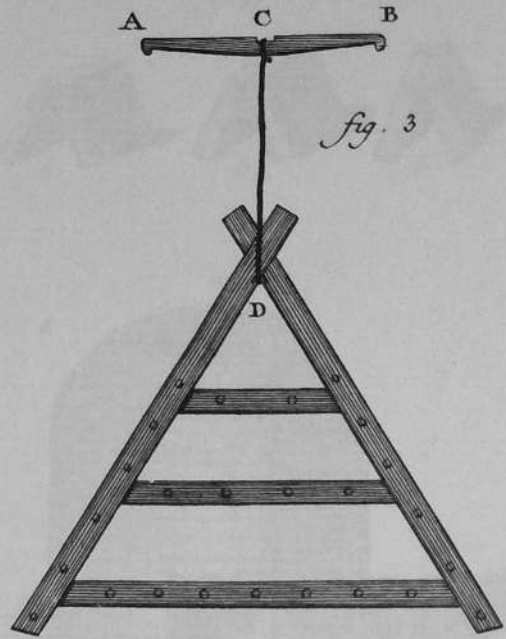

fig. 3

fig. 2 .

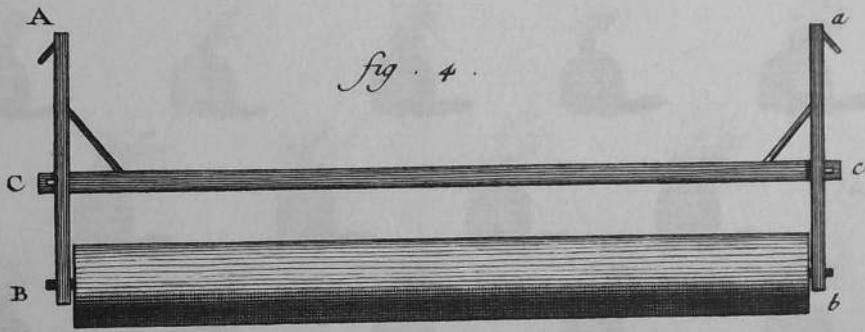

fig. 4 .

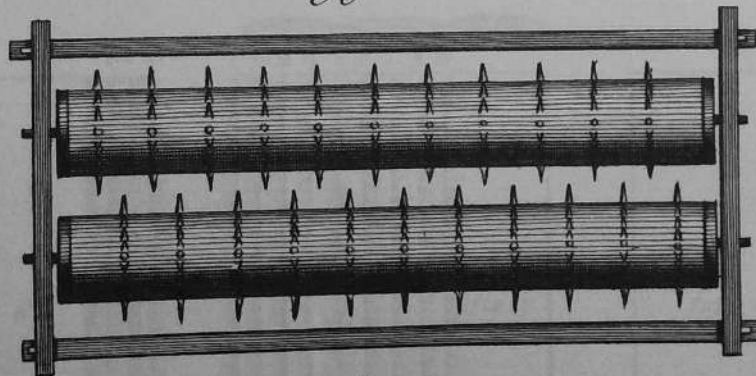

fig. 5 .

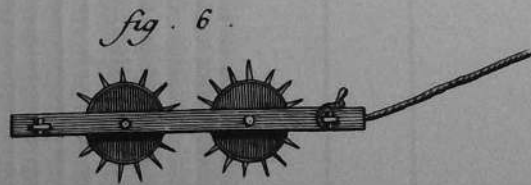

fig. 6 .



Echelle de douze Pieds .

fig. 1.

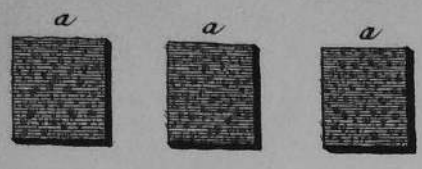

fig. 2.

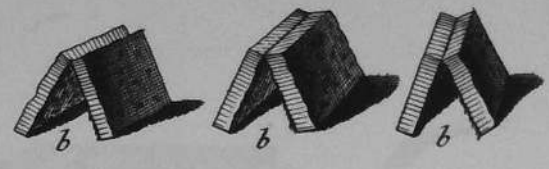

fig. 3.

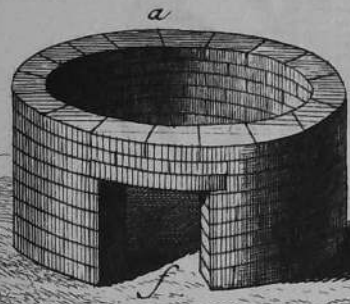

fig. 4.

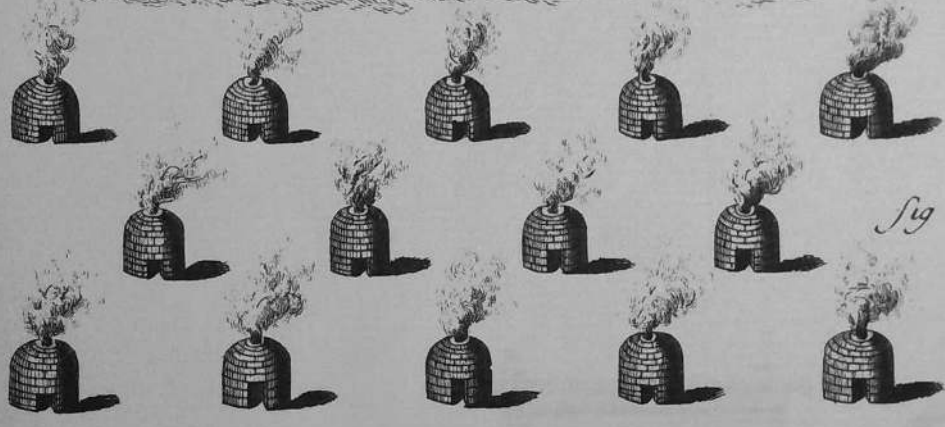
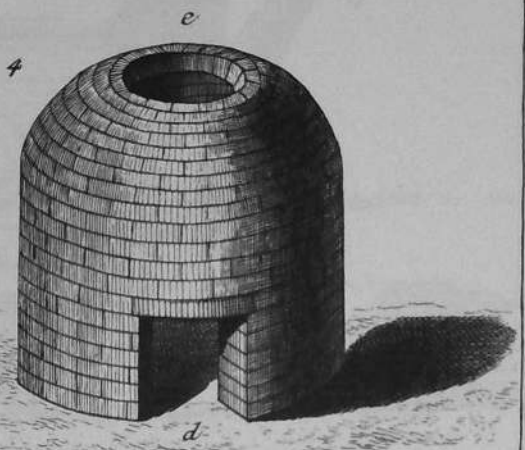

fig. 5.



fig. 6.

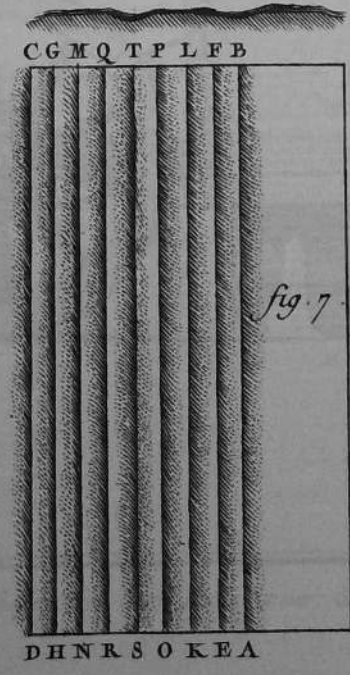

fig. 7.



fig. 8.

figure. 1^{re}

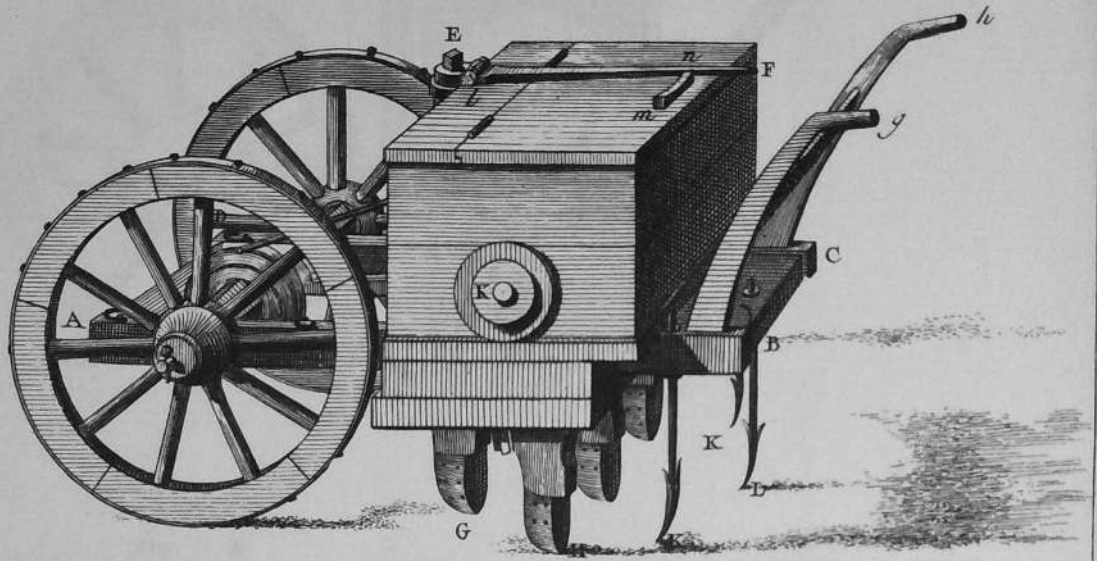
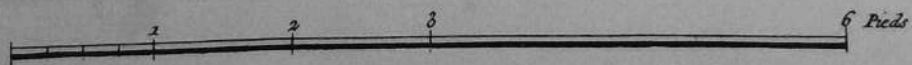
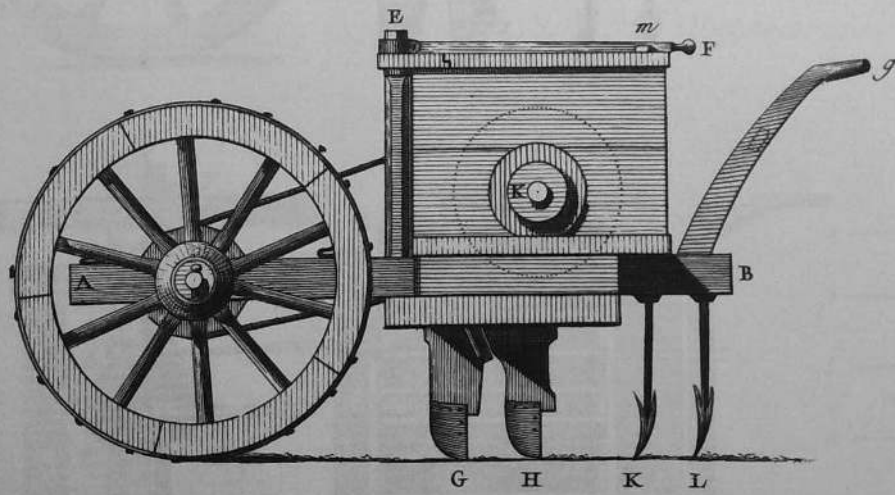

Fig. 2



Echelle de Six Pieds pour toutes les Figures.

fig. 3.

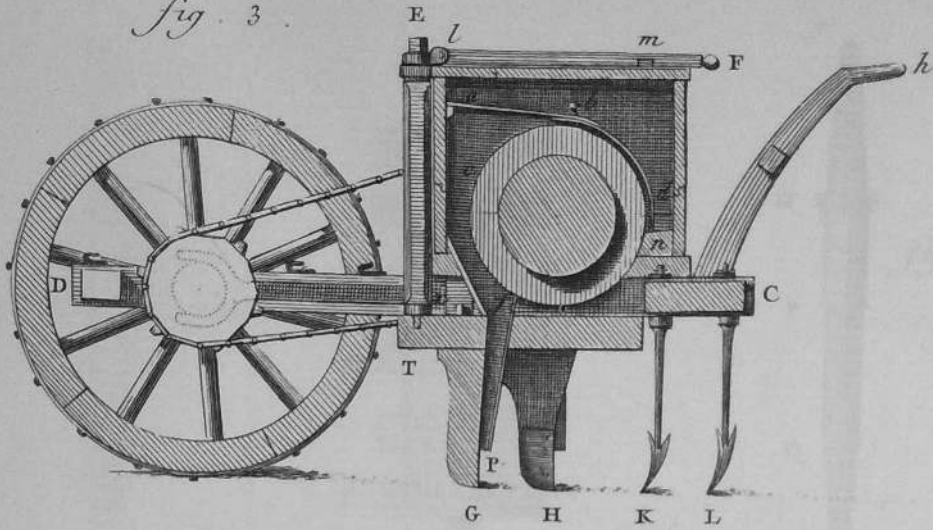

fig. 4.

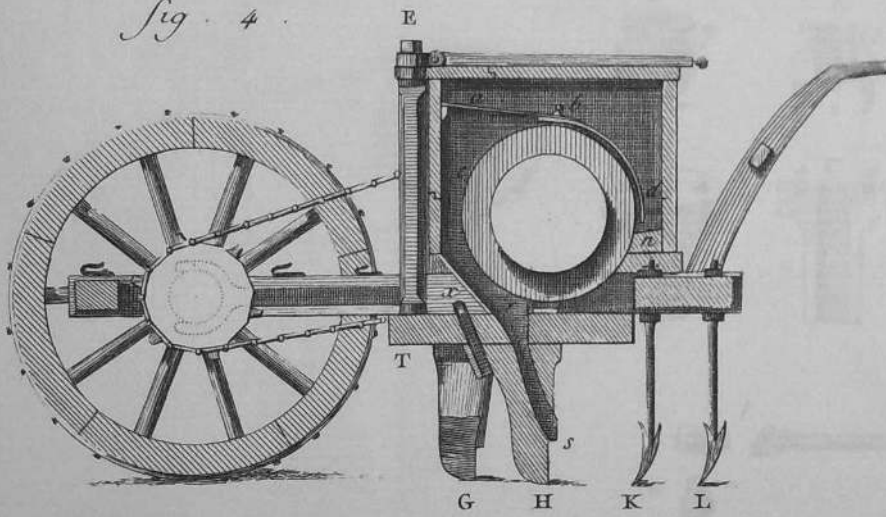

fig. 5.

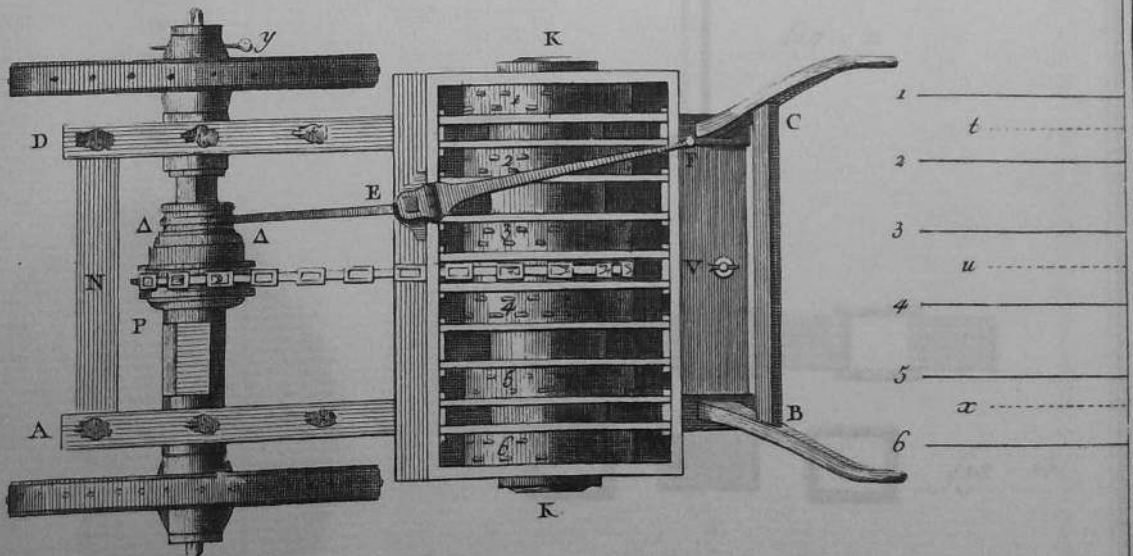
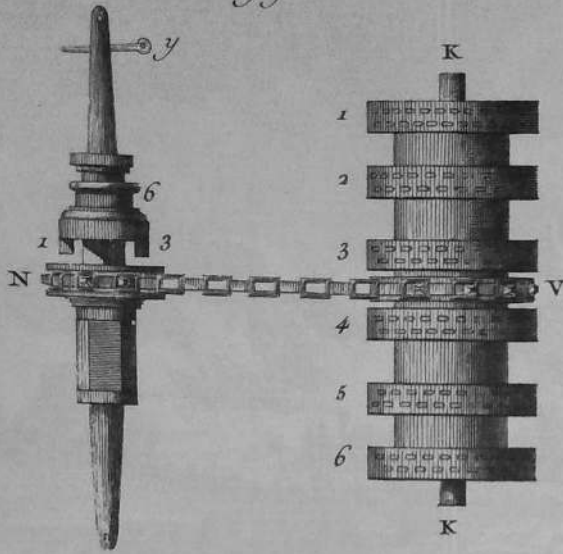

fig. 6.



y

M

P

Q

y

fig. 7.

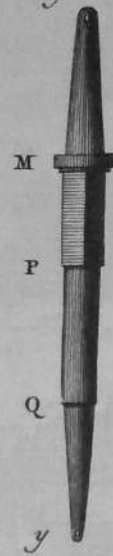

fig. 8.

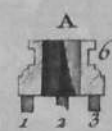
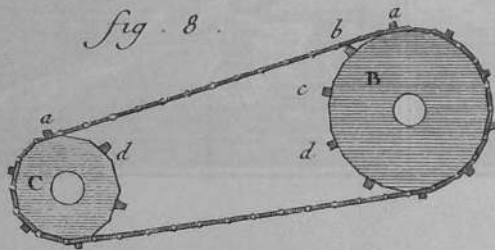

fig. 9.

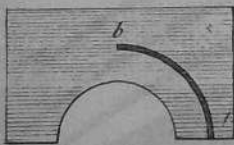
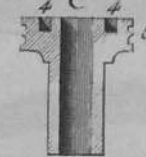

fig. 10.

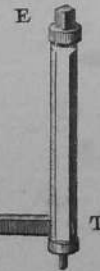

fig. 11.



fig. 12.

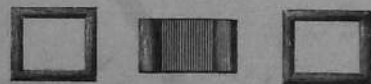
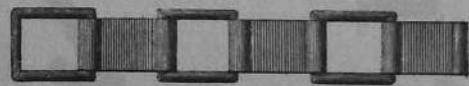
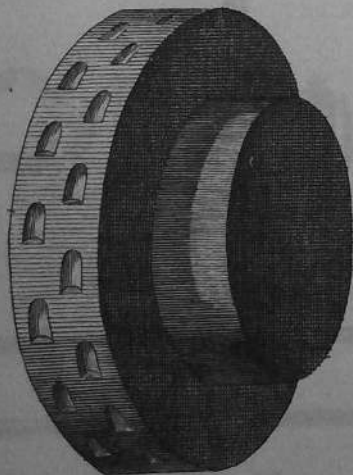
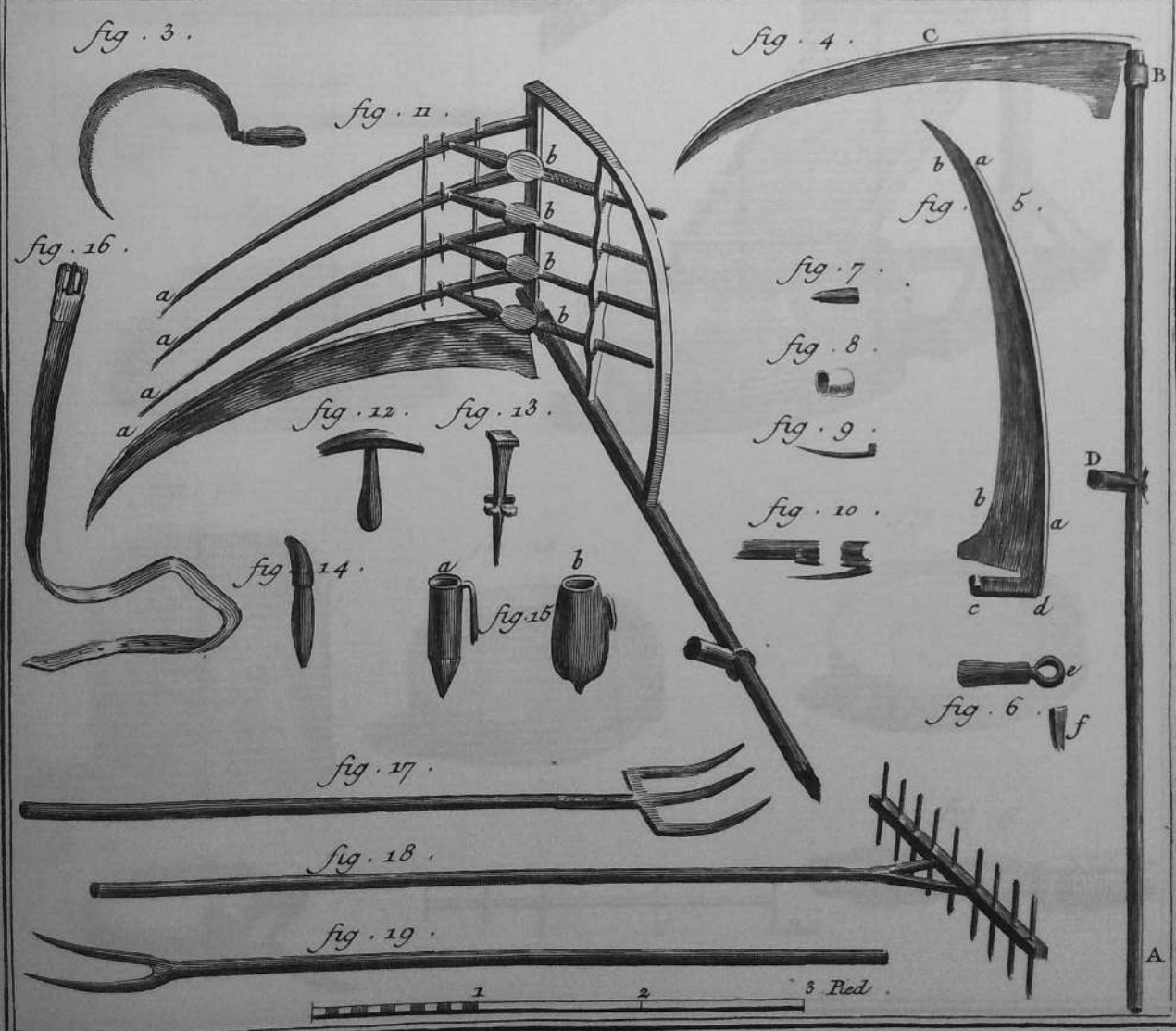

fig. 13.





Agriculture.

Benard Fecit.

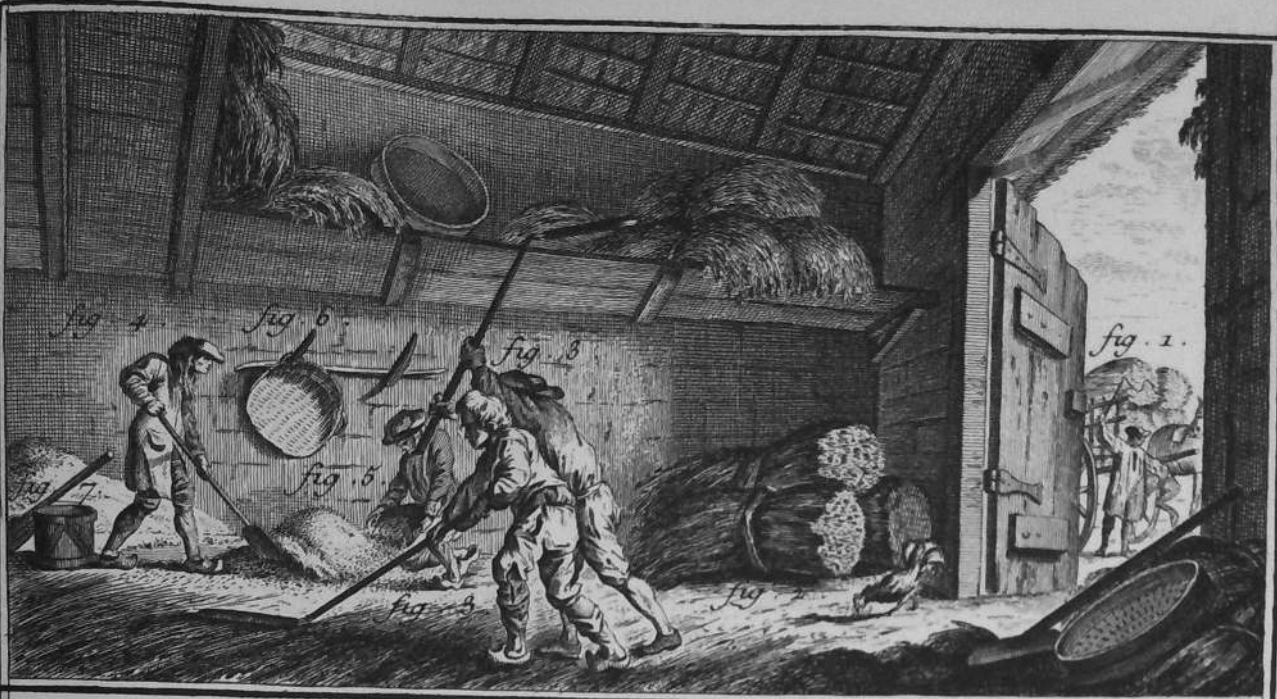

fig. 8.



fig. 11.



fig. 12.

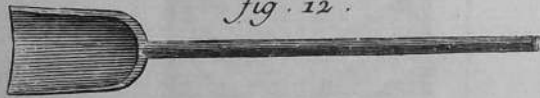

fig. 13.

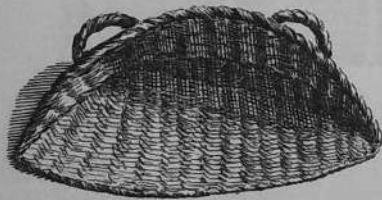

fig. 16.

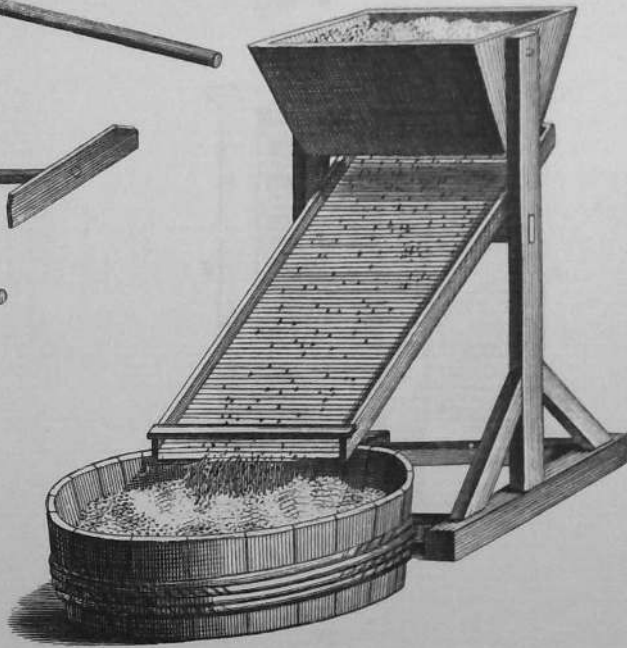

fig. 17.

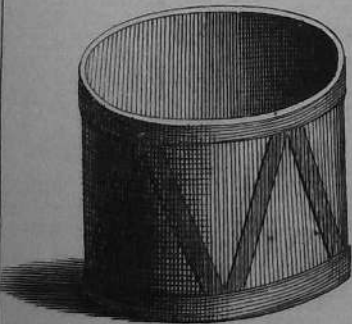

fig. 14.

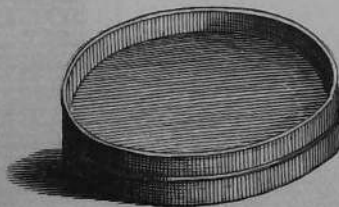

fig. 15.

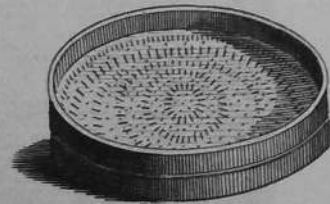

fig. 10.

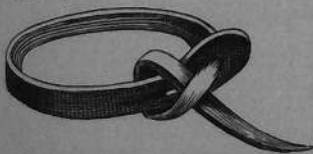
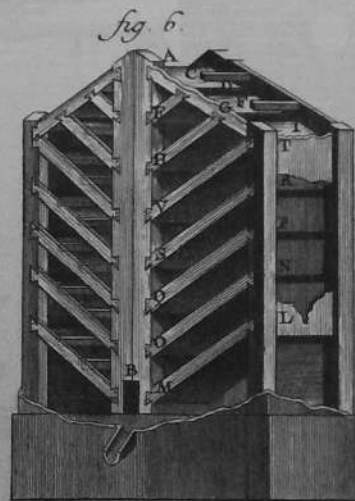
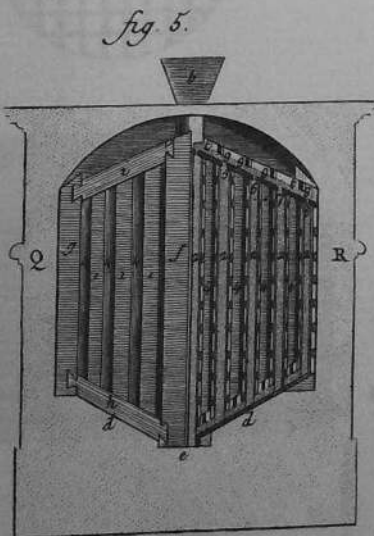
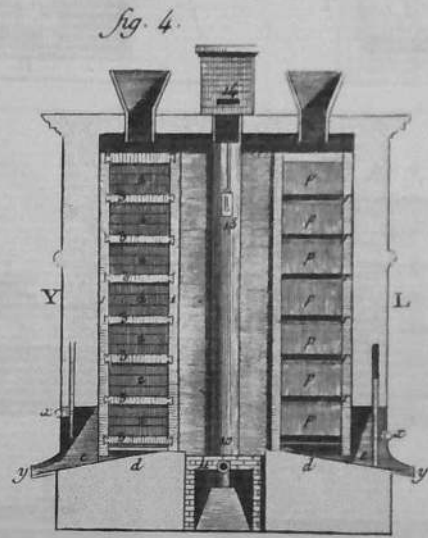
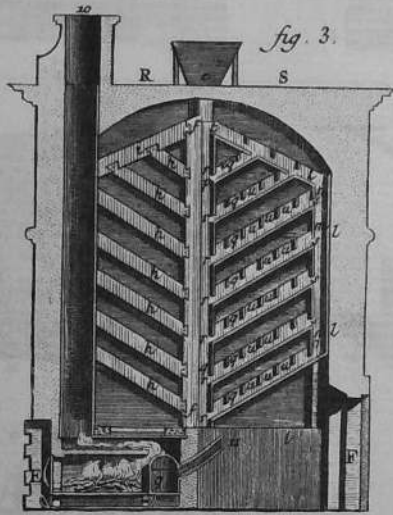
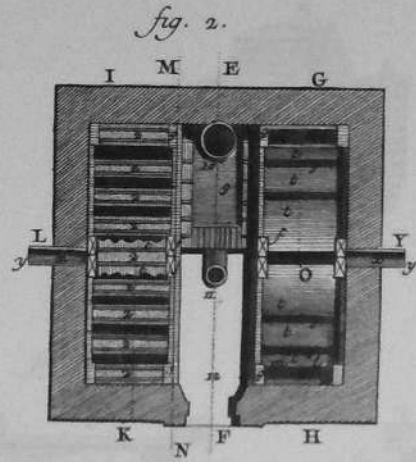
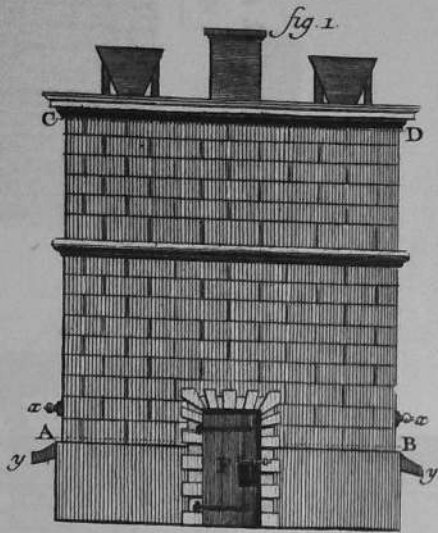

fig. 9.





1 2 3 4 5 6 12 18. Pieds.

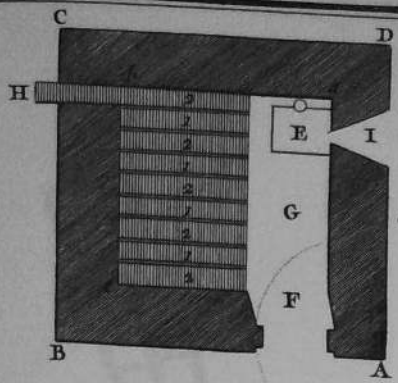

fig. 2.

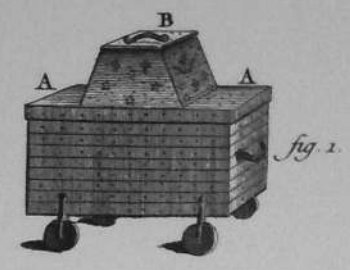

fig. 1.

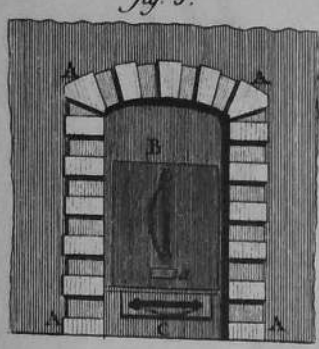

fig. 3.

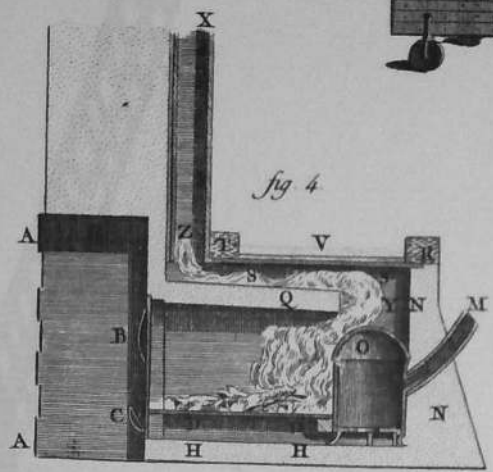

fig. 4.

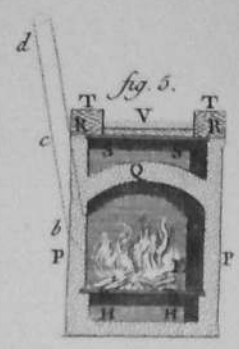

fig. 5.

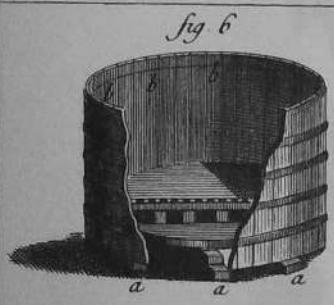

fig. 6.

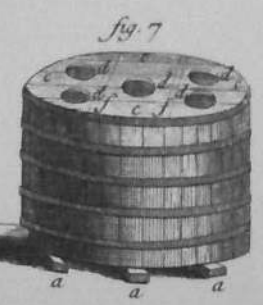
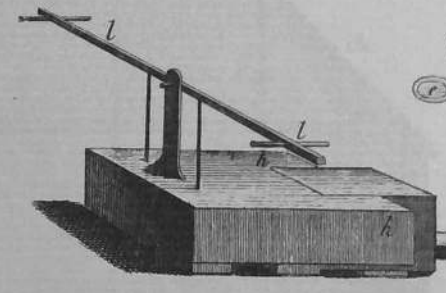

fig. 7.

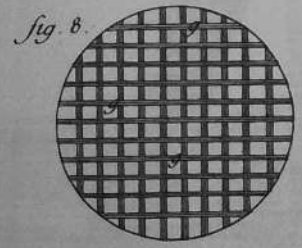

fig. 8.

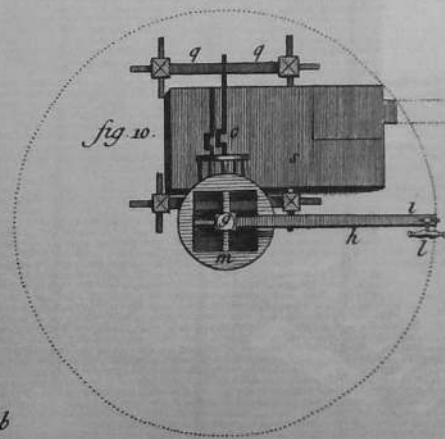

fig. 10.

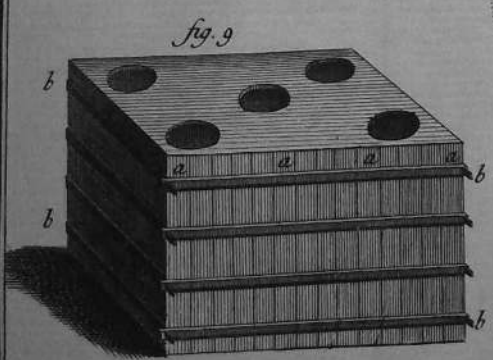
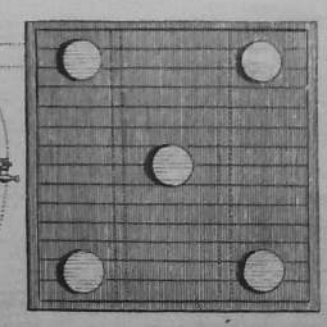

fig. 9.

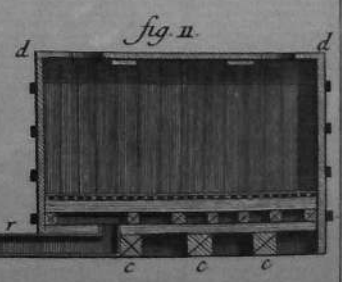
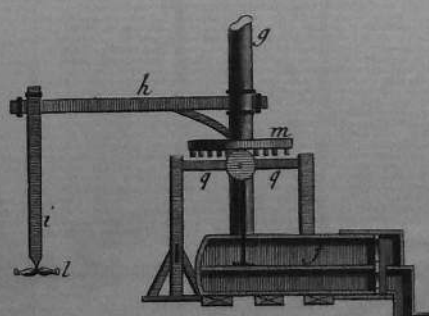
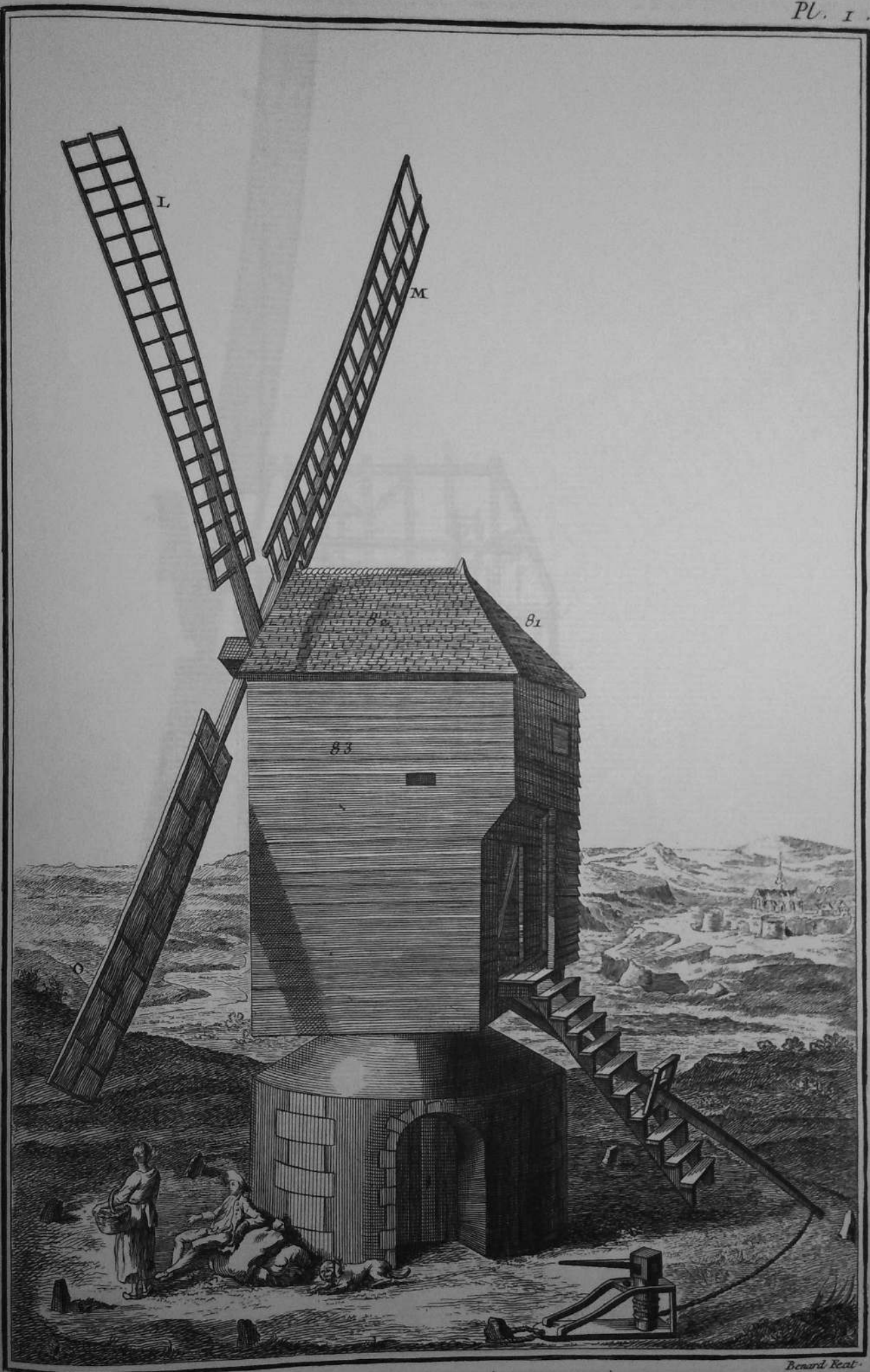

fig. 11.



Goussier del

Benard fecit

Agriculture, Economie Rustique,
Moulin à Vent.

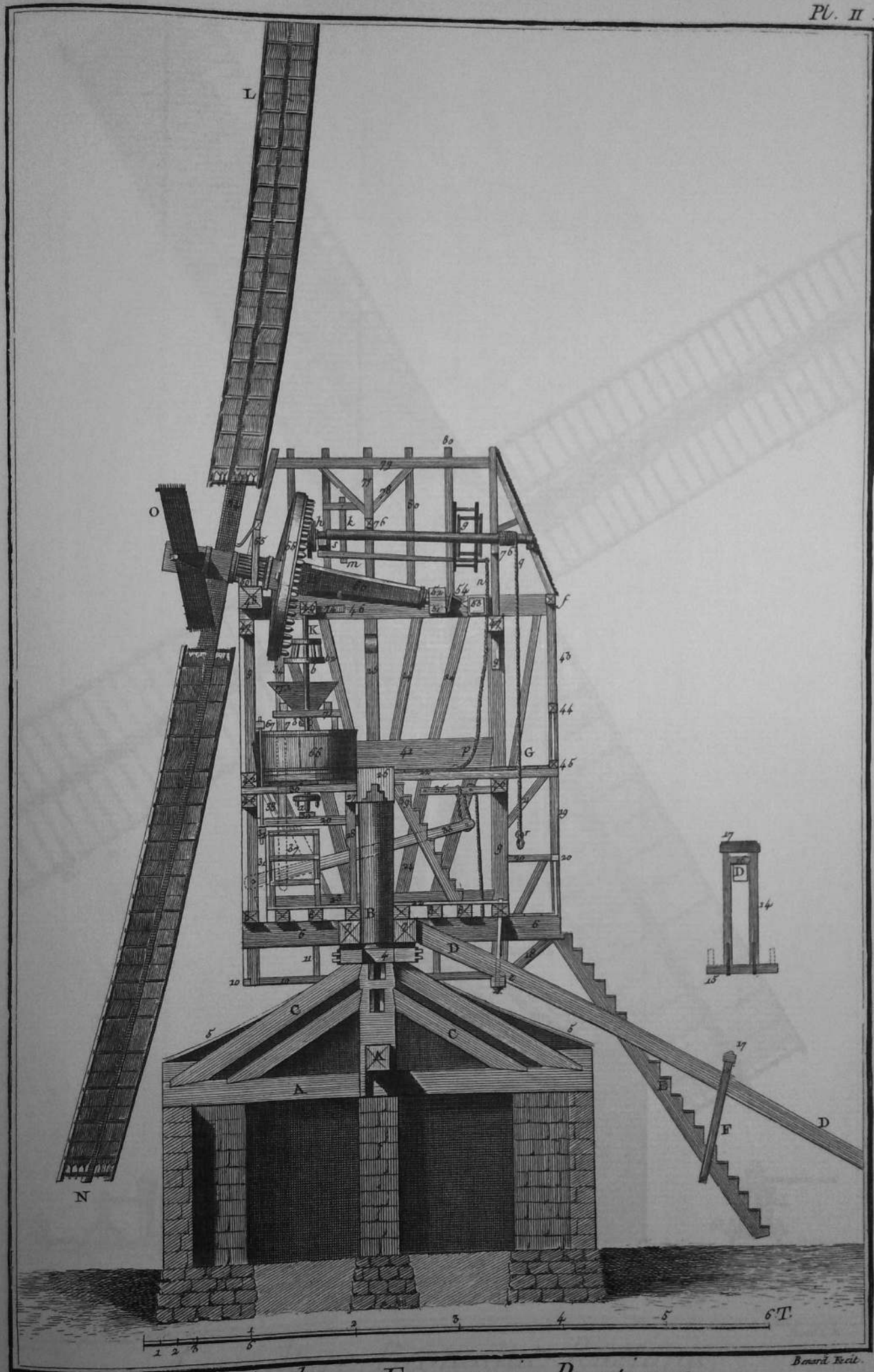

Goussier del.

Agriculture, Economie Rustique.
Moulin à Vent.

Bonsard fecit.

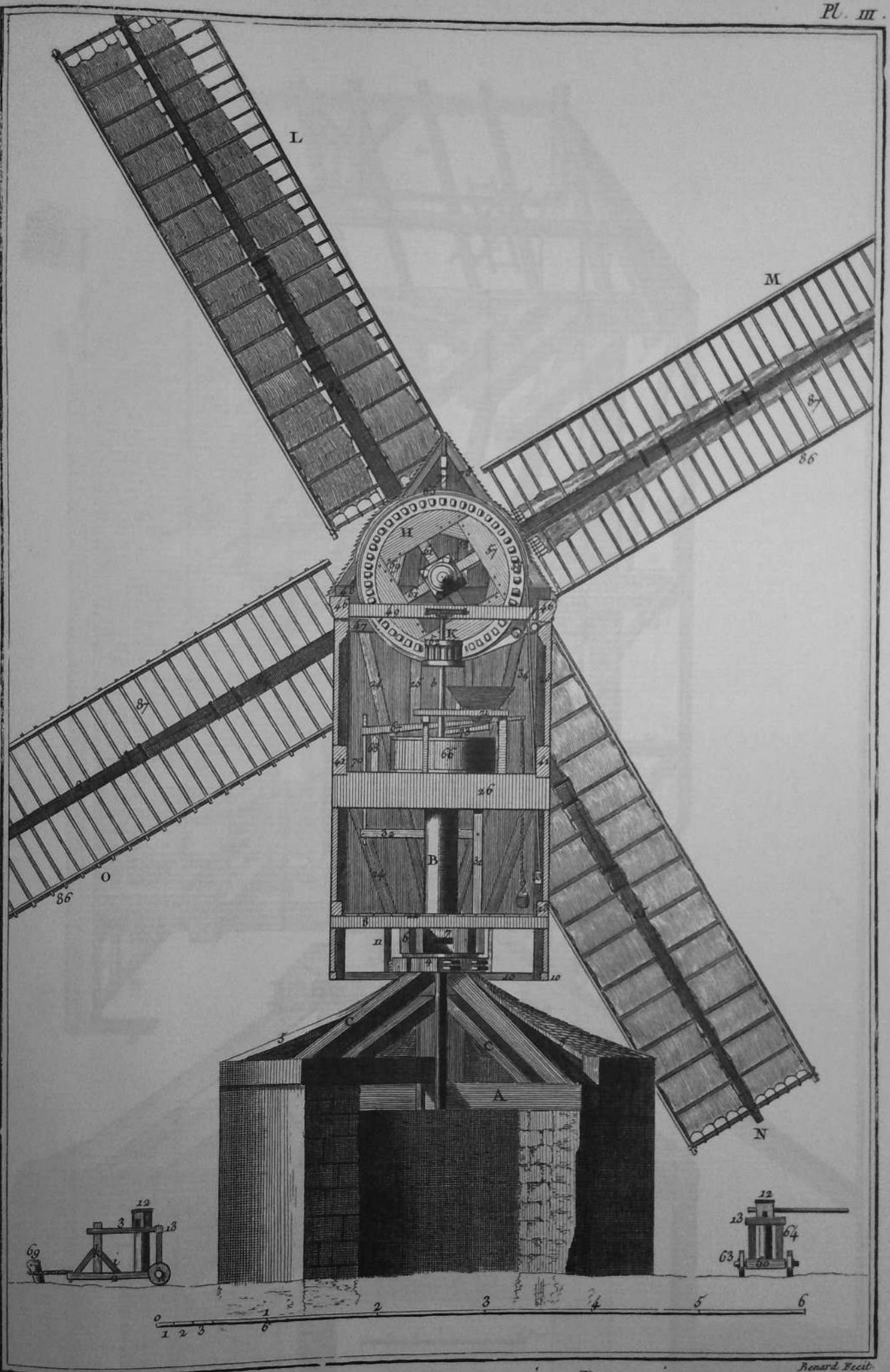

Goussier del.

Renard fecit.

Agriculture, Economie Rustique.
Moulin à Vent.

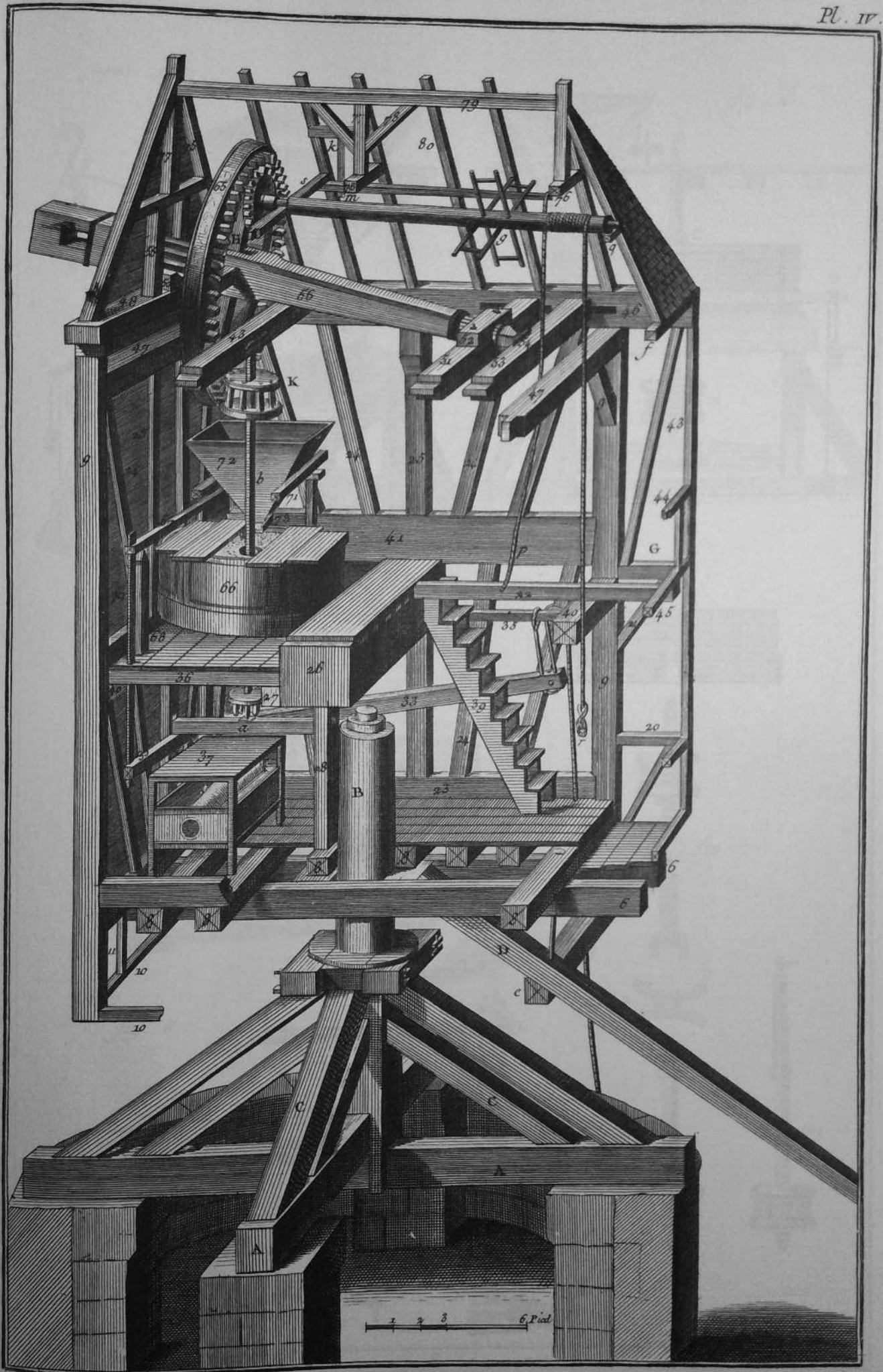

Goussier Del.

Benard Fecit.

Agriculture, Economie Rustique.
Moulin à Vent.

figure . 1.^{re}

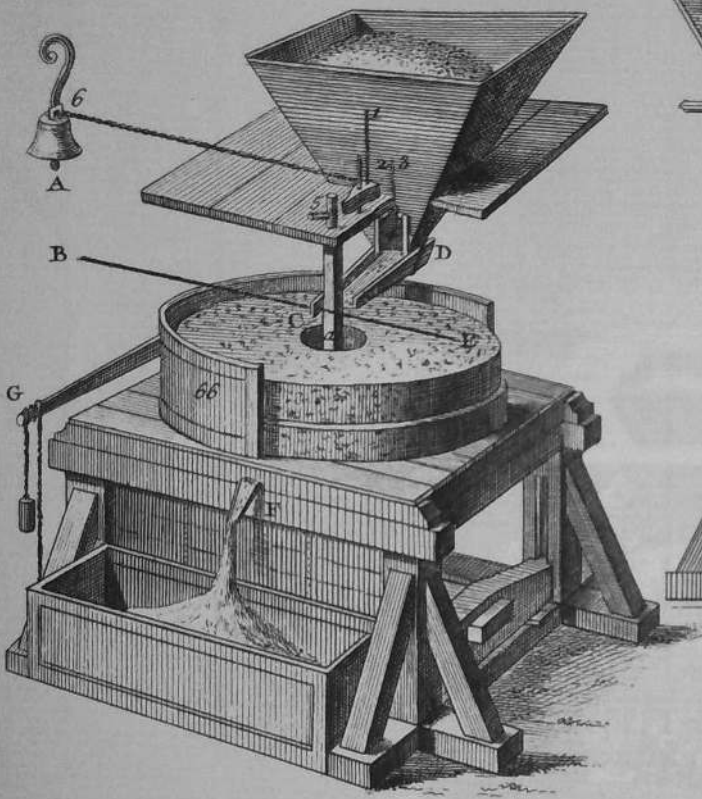

fig . 2 .

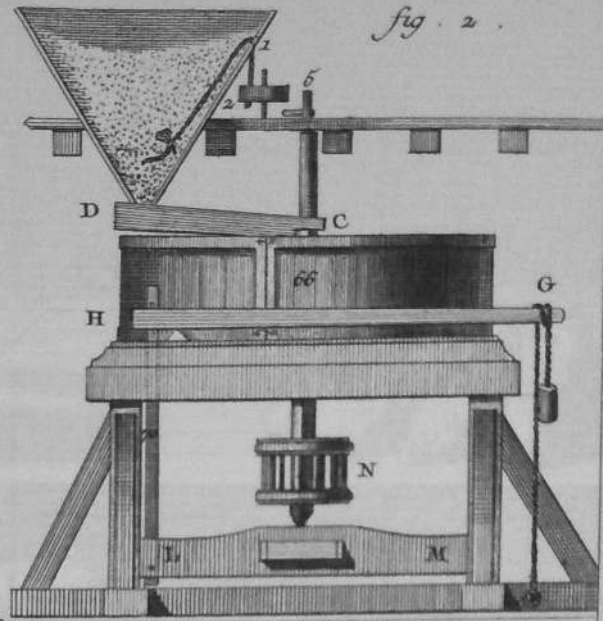

fig . 3 .

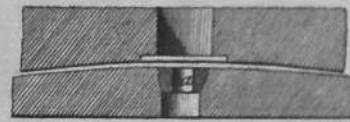

fig . 4 .

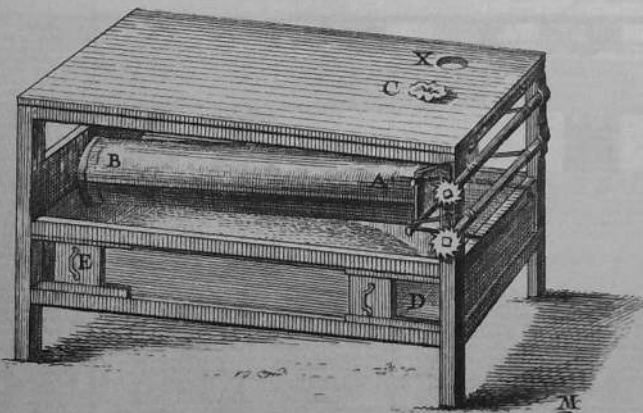

fig . 7 .



fig . 8 .



fig . 10 .

fig . 6 .

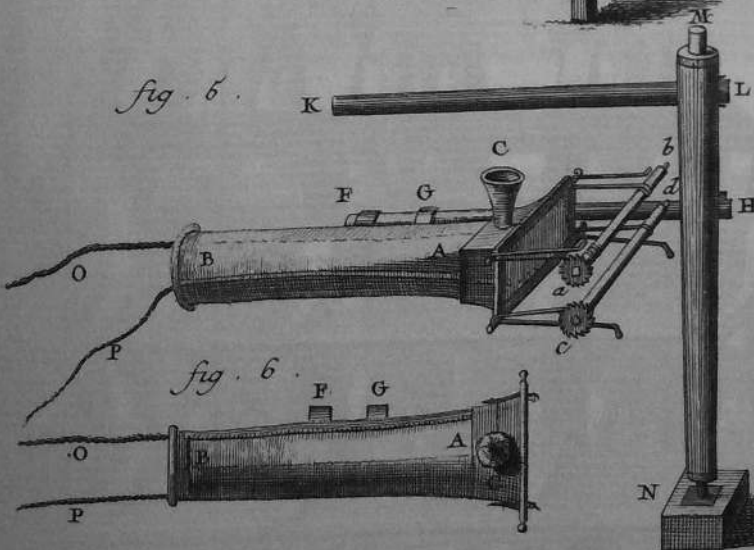
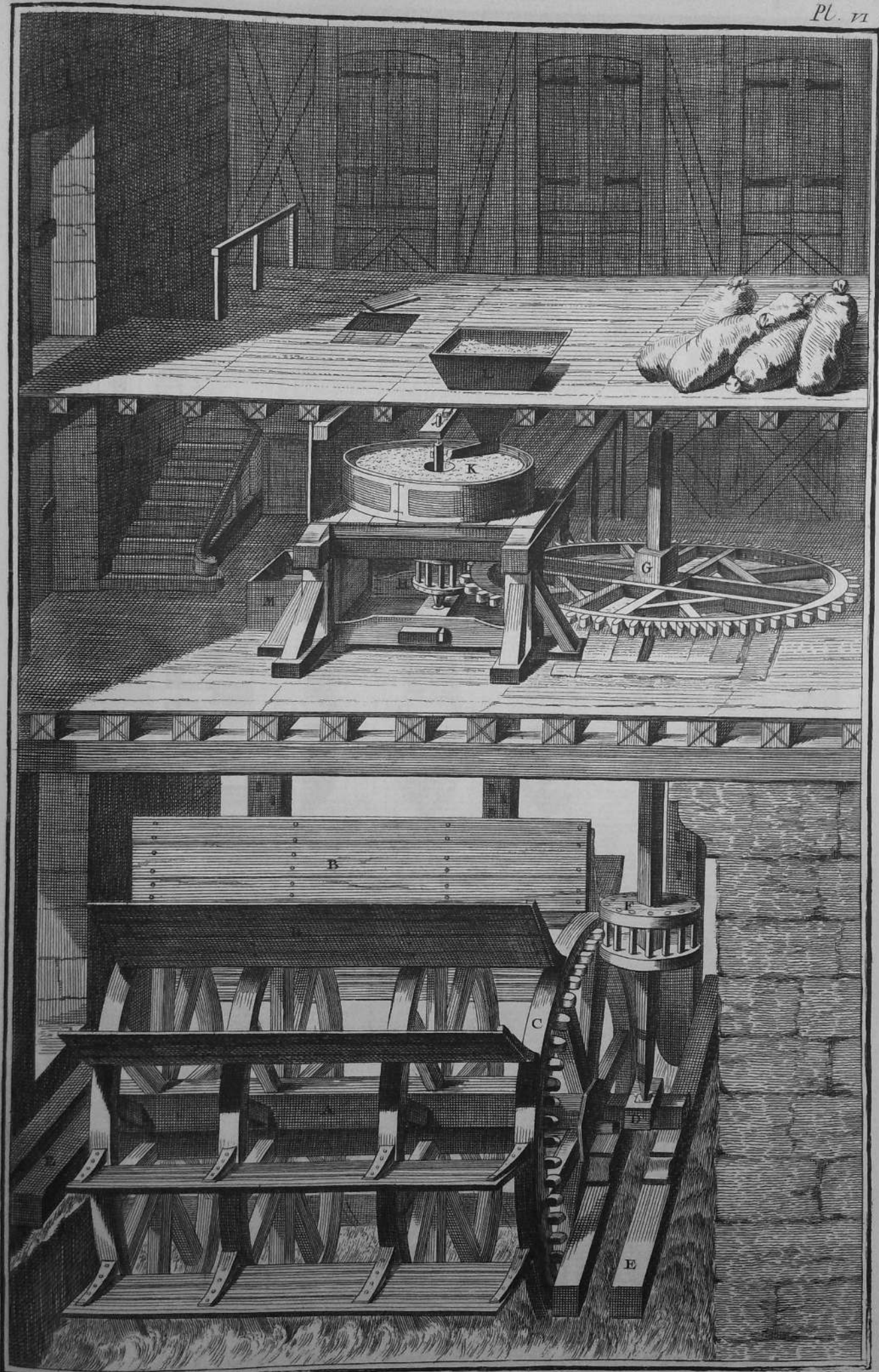

fig . 6 .





Goussier del.

Agriculture, Oeconomie Rustique,
Moulin à Eau.

Benard fecit.

figure . 1.^{re}

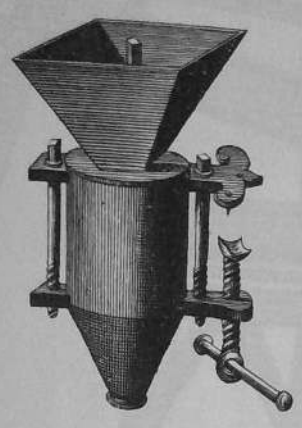

fig . 2 .

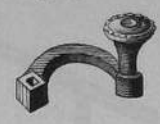

fig . 3 .



fig . 4 .



fig . 5 .



fig . 6 .



fig . 7 .



fig . 8 .



fig . 9 .

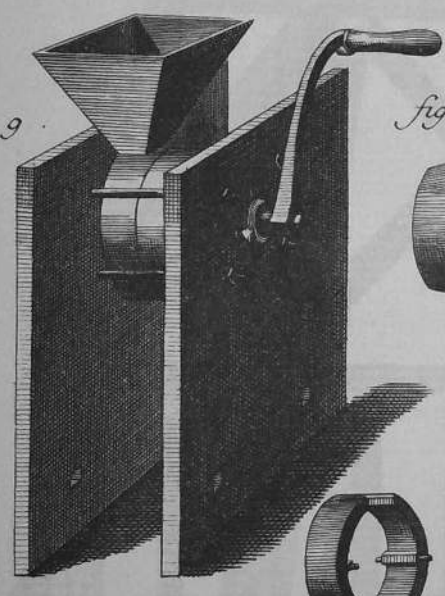

fig . 10 .



fig . 11 .

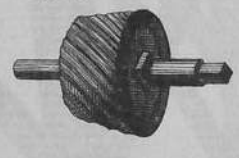

fig . 12 .

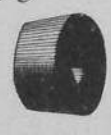

fig . 17 .

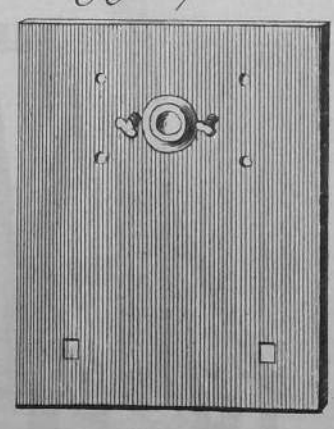

fig . 14 .

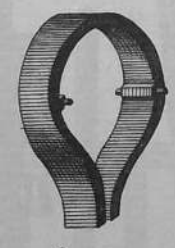

fig . 13 .

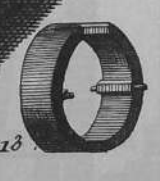

fig . 15 .

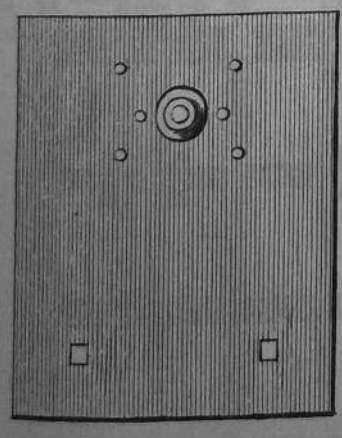

fig . 16 .

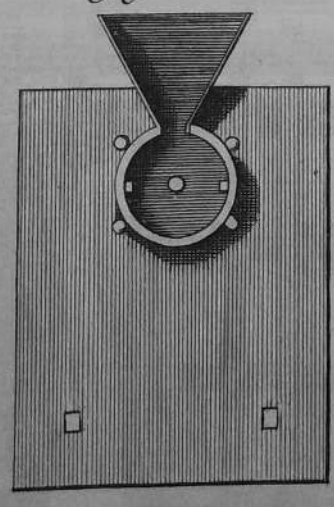

fig . 18 .

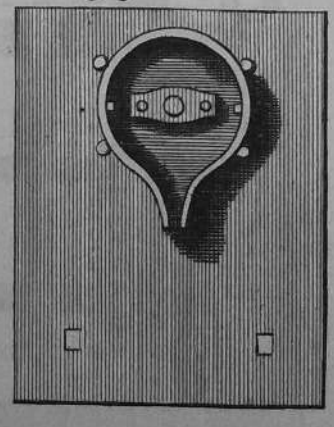



fig. 10.



fig. 9.

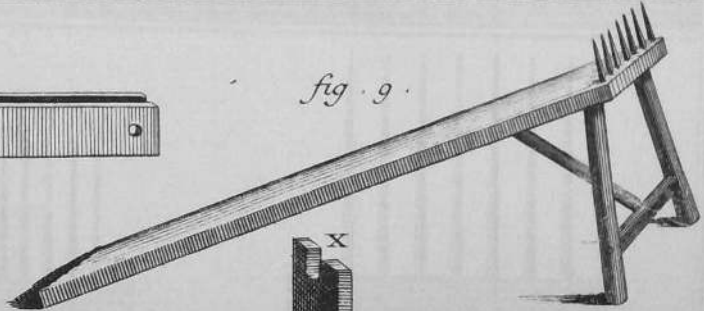

fig. 11.

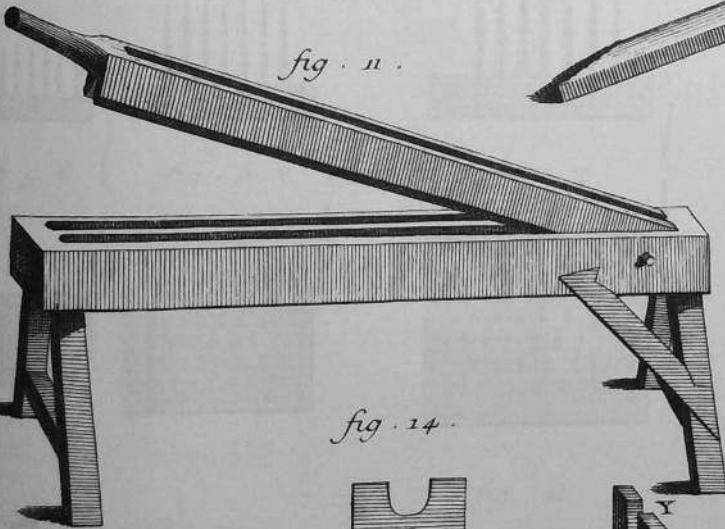

fig. 12.

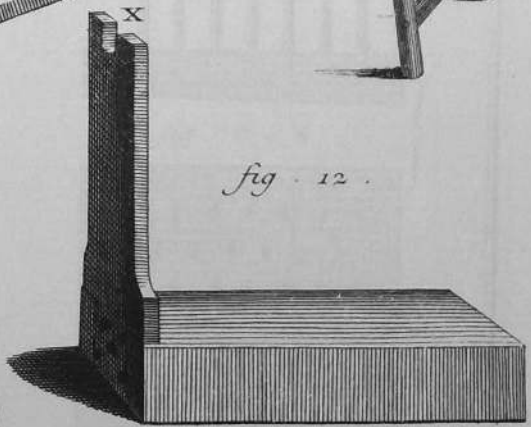

fig. 14.

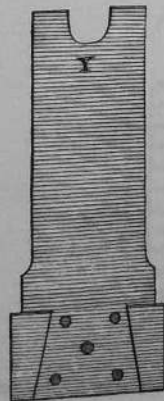

fig. 13.

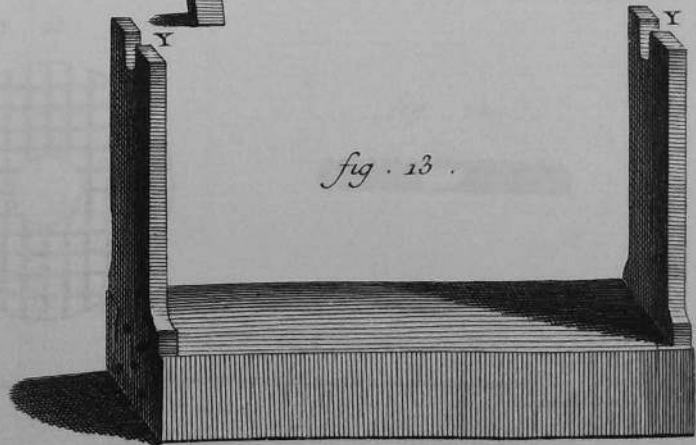
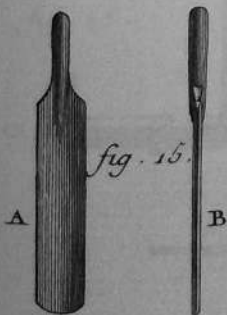

fig. 15.



Bernard Feat.

